

varimed[®]
Furniture for OR theatres
and outpatient departments

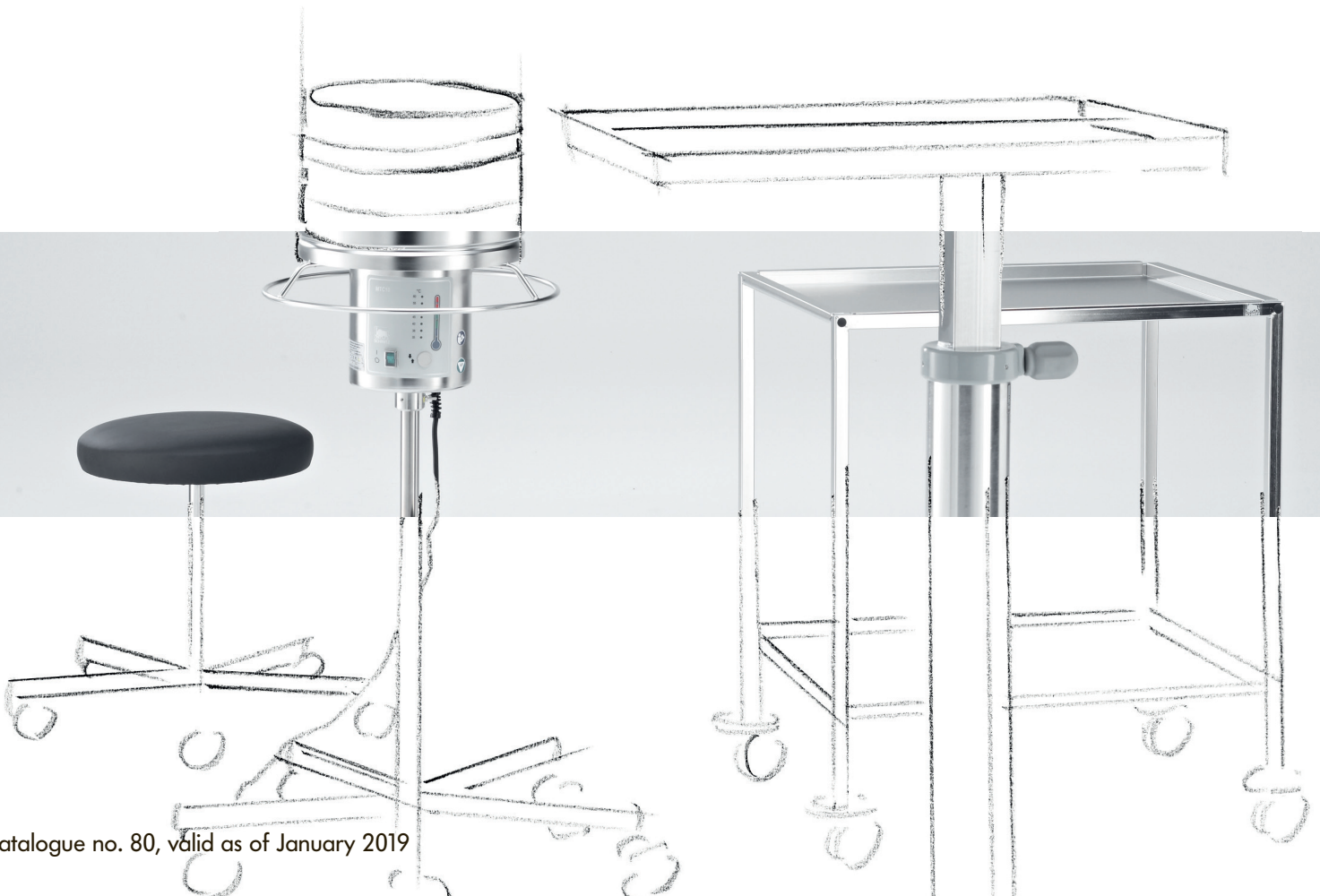

varimed®

OR theatre and outpatient department furniture



Model No.

Description

222.1650.0

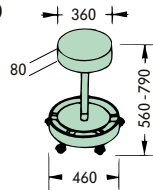

Theatre seat

Specially-designed upholstered seat with antistatic cover, black, height adjustment from 560 to 790 mm by means of gas spring, with foot ring release. 5-arm pedestal powder coated in grey aluminium RAL 9007 with antistatic double plastic castors of 50 mm, unbraked when loaded, circular black bumper. Safe working load: 135 kg

200.0011.0

**Surcharge for brake loaded castors
braked when loaded,** released when you come off the stool.

222.1670.0

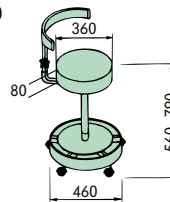

Theatre seat

Specially-designed upholstered seat with antistatic cover, black, height adjustment from 560 to 790 mm by means of gas spring, with foot ring release, back rest with antistatic cover. 5-arm pedestal powder coated in grey aluminium RAL 9007 with antistatic double plastic castors of 50 mm, unbraked when loaded, circular black bumper. Safe working load: 135 kg

200.0011.0

**Surcharge for brake loaded castors
braked when loaded,** released when you come off the stool.

222.1660.0

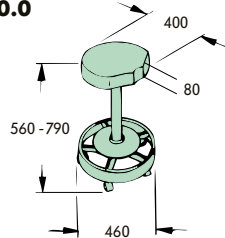

Theatre seat

Saddle-shaped pad with antistatic cover, black, height adjustment from 560 to 790 mm by means of gas spring, with foot ring release. 5-arm pedestal powder coated in grey aluminium RAL 9007 with antistatic double plastic castors of 50 mm, unbraked when loaded, circular black bumper. Safe working load: 135 kg

200.0011.0

**Surcharge for brake loaded castors
braked when loaded,** released when you come off the stool.

222.1680.0

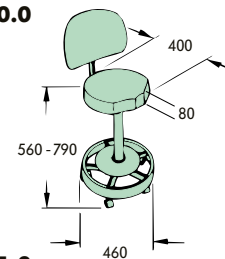

Theatre seat

as 222.1660.0, but with back rest with antistatic cover, black. 5-arm pedestal powder coated in grey aluminium RAL 9007 with antistatic double plastic castors of 50 mm, unbraked when loaded, circular black bumper. Safe working load: 135 kg

200.0011.0

**Surcharge for brake loaded castors
braked when loaded,** released when you come off the stool.

Plastic castors
with axle and
fastening pin of
stainless steel



Model No.

Description

222.1530.0

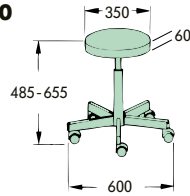

Surgeon's stool

5-arm pedestal in 18/10 stainless steel, antistatic double castors diam. 50 mm of plastic material, rust-proof, seat disc upholstered, antistatic cover, black. Height adjustment by means of threaded spindle with end stop, seat diam. 350 mm, height adjustment from 485 to 655 mm. Safe working load: 135 kg

varimed®

OR theatre and outpatient department furniture



232.4170.0

Model No.

Description

232.4170.0

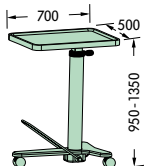

Instrument serving table CE/93/42/EEC with foot-operated pump, height adjustment from 950 to 1,350 mm by means of foot bar, 18/10 stainless steel table top 700 x 500 mm, with raised edge, 360° rotatable, to be fixed in each position, rounded corners and edges; support column and frame in 18/10 stainless steel, pedestal clad in stainless steel, double plastic castors diam. 75 mm, ball bearing, antistatic, rust-proof. Safe working load with table-top in any position: 30 kg.

232.4180.0

Instrument serving table CE/93/42/EEC as 232.4170.0, but table top 600 x 400 mm.

200.0012.0

Surcharge for 2 castors with lock.

232.4190.0

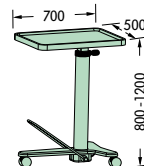

Instrument serving table CE/93/42/EEC as 232.4170.0, but height adjustment from 800 to 1,200 mm.

232.4200.0

Instrument serving table CE/93/42/EEC as 232.4170.0, but table top 600 x 400 mm, height adjustment from 800 to 1,200 mm.

200.0012.0

Surcharge for 2 castors with lock.

- Enhanced cleaning and disinfecting properties thanks to electropolished surface
- 360° rotatable table top even when charged with a load of 30 kg
- High-quality hydraulic pump passing toughest of endurance tests
- 400 mm height adjustment range requires only 25 pumping actions
- Rounded edges of the table-top minimize the risk of injury to the OR team



232.4260.0

232.4260.0

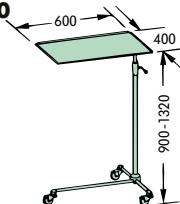

Instrument serving table 18/10 stainless steel frame, 18/10 stainless steel table top 600 x 400 mm, non-rotatable, height adjustable from 900 to 1,320 mm, double plastic castors diam. 50 mm, antistatic, rust-proof. Safe working load: 12 kg.



232.4270.0

Model No.

Description

232.4270.0

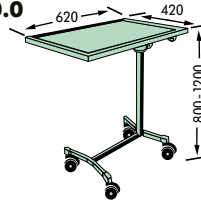

Instrument serving table

manually operated height adjustment from 800 – 1,200 mm. Mobile 4-arm pedestal of 18/10 stainless steel and stainless steel table, top with reflex free and disinfectant-proof surface. 4 swivel castors, 2 of which lockable, resistant to abrasions, antistatic, diam. 75 mm, with friction bearing. Safe working load: 30 kg



232.4460.0
200.4110.0

232.4460.0

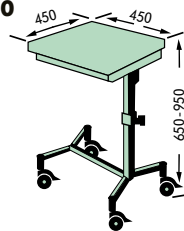

Hand and arm operating table C€/93/42/EEC – discontinued model –

pedestal of 18/10 stainless steel. Table top X-ray permeable, tiltable by means of ball-and-socket-joint, with clamping lever. Manually height adjustable from 650 – 950 mm. 4 swivel castors, lockable, resistant to abrasions, antistatic, diam. 75 mm, with friction bearing. Safe working load: 40 kg.

200.4110.0

Accessories:

Upholstered pad

– discontinued model –

antistatic, X-ray permeable, detachable, 450 x 450 x 30 mm.

varimed® OR theatre and outpatient department furniture



Model No.	Description
232.5210.0	Instrument table 18/10 SST rectangular tube frame (frame also serves as protection rail), 18/10 SST table tops 600 x 450 mm, detachable, table height 800 mm, 4 plastic double castors diam. 75 mm, antistatic, antirust, abrasion-proof, 2 of which lockable, with 4 bumpers. Safe working load per shelf: 50 kg
232.5220.0	Instrument table , as 232.5210.0, but of 900 mm height.
232.5310.0	Instrument table 18/10 SST rectangular tube frame, two stainless steel 18/10 shelves, top shelf 650 x 500 mm covering frame, lower one as inserted plate of 600 x 450 mm, detachable, table height 800 mm, 4 plastic double castors diam. 75 mm, antistatic, antirust, abrasion-proof, 2 of which lockable, with 4 bumpers. Safe working load per shelf: 50 kg
232.5320.0	Instrument table , as 232.5310.0, but of 900 mm height.
232.5410.0	Instrument table 18/10 SST rectangular tube frame (frame also serves as protection rail), 18/10 SST table tops 700 x 600 mm, detachable, table height 800 mm, 4 plastic double castors diam. 75 mm, antistatic, antirust, abrasion-proof, 2 of which lockable, with 4 bumpers. Safe working load per shelf: 50 kg
232.5420.0	Instrument table , as 232.5410.0, but of 900 mm height.
232.5510.0	Instrument table 18/10 SST rectangular tube frame, two stainless steel 18/10 shelves, top shelf 750 x 650 mm covering frame, lower one as inserted plate of 700 x 600 mm, detachable, table height 800 mm, 4 plastic double castors diam. 75 mm, antistatic, antirust, abrasion-proof, 2 of which lockable, with 4 bumpers. Safe working load per shelf: 50 kg
232.5520.0	Instrument table , as 232.5510.0, but of 900 mm height.
232.5610.0	Instrument table 18/10 SST rectangular tube frame (frame also serves as protection rail), 18/10 SST table tops 900 x 600 mm, detachable, table height 800 mm, 4 plastic double castors diam. 75 mm, antistatic, antirust, abrasion-proof, 2 of which lockable, with 4 bumpers. Safe working load per shelf: 50 kg
232.5620.0	Instrument table , as 232.5610.0, but of 900 mm height.
232.5710.0	Instrument table 18/10 SST rectangular tube frame, two stainless steel 18/10 shelves, top shelf 950 x 650 mm covering frame, lower one as inserted plate of 900 x 600 mm, detachable, table height 800 mm, 4 plastic double castors diam. 75 mm, antistatic, antirust, abrasion-proof, 2 of which lockable, with 4 bumpers. Safe working load per shelf: 50 kg
232.5720.0	Instrument table , as 232.5710.0, but of 900 mm height.

Plastic castors with axle and fastening pin of stainless steel

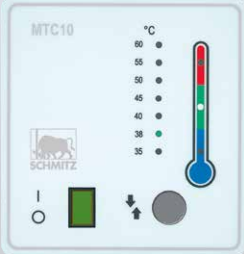

Safety thermostat

242.1250.0

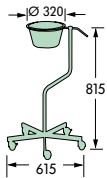

Bowl stand

18/10 stainless steel frame, one 18/10 SST bowl, capacity 6 l, plastic double castors diam. 50 mm, antistatic, rust-proof, height 815 mm, **disassembled**.

200.3070.0

Accessories:

Bowl, 18/10 stainless steel (extra).

242.1350.0



Bowl stand

18/10 stainless steel frame, two 18/10 SST bowls, capacity 6 l ea., plastic double castors diam. 50 mm, antistatic, rust-proof, height 815 mm, **disassembled**.

200.3070.0

Accessories:

Bowl, 18/10 stainless steel (extra).

242.1310.0

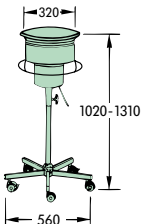

Bowl stand CE/93/42/EEC

for heating of physiological saline solutions, with button to switch the temperature from 35° C to max. 60° C, with safety thermostat and scale reading. Teflon-coated heating plate for easy cleaning. 5-arm base of stainless steel, height adjustable by servo-assisted gas cylinders; plastic castors diam. 75 mm, rust-proof, with brake, 3 of which antistatic, SST bowl with litre-scale, capacity 5 l. Earth contact. Voltage: 230 V, 50 Hz, 400 W, connection cable with EPR (earth potential rise) protection, 5 m long with plug.

200.5600.0

200.5610.0

Accessories:

5 L Bowl, stainless steel 18/10, with litre-scale (extra)

Fastening ring, for aseptic cover

Important: For reasons of safety only use original bowls from SCHMITZ.

varimed®

OR theatre and outpatient department furniture

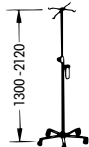
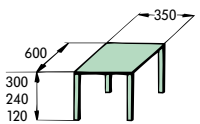
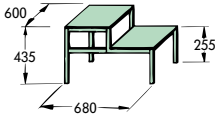
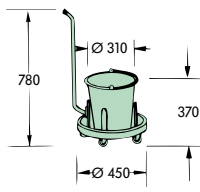

Model No.	Description
242.2350.0 	Drip-feed stand CE/93/42/EEC 18/10 stainless steel frame, disassembled, 5-arm base, upper section with 4 hooks, drip glass, double plastic castors diam. 50 mm, antistatic, rust-proof; height adjustment from 1,300 to 2,120 mm, one-hand action. Safe working load: 2 kg (per hook).
251.1010.0 251.1030.0 251.1040.0 	Step 18/10 stainless steel frame, fine-ribbed anti-slip tread in 18/10 stainless steel, floor pads antistatic, tread height 240 mm. Step , as 251.1010.0, but tread height 120 mm. Step , as 251.1010.0, but tread height 300 mm. Safe working load: 185 kg
251.1020.0 	Step 18/10 stainless steel frame, fine-ribbed anti-slip treads in 18/10 stainless steel, floor pads antistatic. Safe working load: 185 kg
252.1180.0 252.1190.0 200.1370.0 200.1350.0 	Refuse bucket removable 12 l bucket in 18/10 stainless steel, 18/10 stainless steel frame with profiled plastic wrap-around bumper, double plastic castors diam. 50 mm, antistatic, rust-proof; frame height 230 mm. Refuse bucket as 252.1180.0 above, with pushing handle in 18/10 stainless steel. Accessories: Bucket lid in 18/10 stainless steel. 12 L Bucket in 18/10 stainless steel (extra).

varimed®

OR theatre and outpatient department furniture

Accessories

Material description

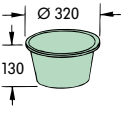
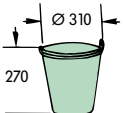
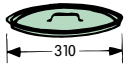
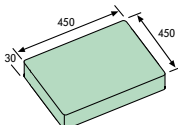
Model No.	Description	Model No.	Description	Model No.	Description
200.3070.0	Bowl for bowl stands 242.1250.0 and 242.1350.0, 18/10 SST, diam. of 320 mm, depth of 130 mm.	200.1350.0	12 L Bucket SST 18/10 for 252.1180.0 - 252.1190.0.	200.1370.0	Lid for 12 l. bucket, 18/10 SST.
					
200.5610.0	Fastening ring for aseptic cover for 242.1310.0.	200.4110.0	Pad antistatic, X-ray permeable, for hand and arm operating table 232.4460.0.	200.5600.0	Bowl stainless steel 18/10, with litre-scale for 242.1310.0.
					

Material description

Frames in SST 18/10, round or rectangular tubing, electropolished. Stainless steel tops as well as claddings are of ground, brushed finish (grain size 180).

All castors are resistant to abrasions.

Seat upholsteries of top quality, hardwearing foam rubber with antistatic black cover.

**SCHMITZ u. Söhne
GmbH & Co. KG**

P. O. Box 14 61
58734 Wickede (Ruhr)
Germany (postal address)
Zum Ostenfeld 29
58739 Wickede (Ruhr)
Germany (visiting address)
T +49 (0)2377 84 0
F +49 (0)2377 84 135
www.schmitz-soehne.com
export@schmitz-soehne.de

Technical service, hotline:
T +49 (0)2377 84 549
F +49 (0)2377 84 210
service@schmitz-soehne.de

All articles including correspond-
ing accessories marked with
the CE label meet the standards
for medical devices acc. to
MPG and the EC regulation
93/42/EEC.



The products may only be used
for their intended purpose of use.
Please also observe our operating
manual!

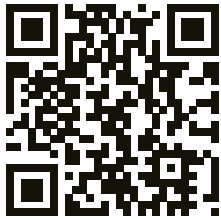

[f/schmitz.soehne](https://www.facebook.com/schmitz.soehne)



**Information on
our establishments
worldwide can be found
on our website.**

DIAMOND
A class of its own

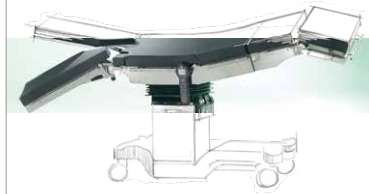

**OPX mobilis® Operating Tables
for Outpatient Departments
and Operating Theatres
Unique Flexibility and Reliability**

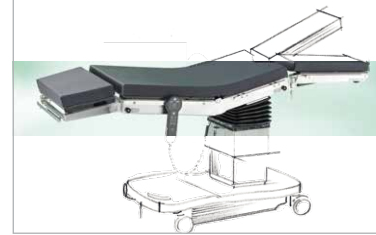

**Accessories for
DIAMOND and OPX mobilis®
operating tables**

